

Nodige pictogrammen  
(on-)drinkbaar water  
aanbrengen.

 Waterslagdemper  
oordeelkundig te plaatsen..

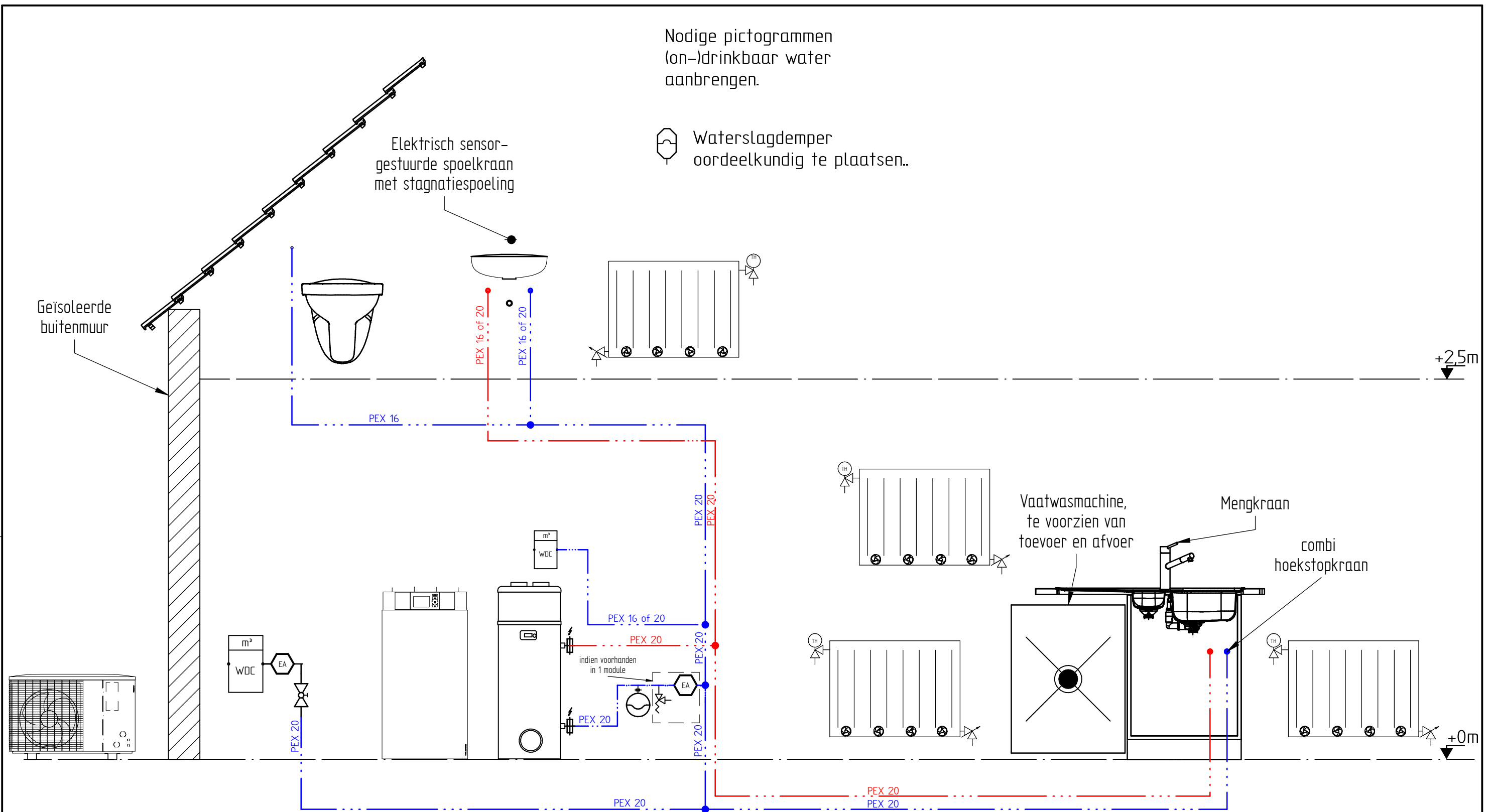



Elektrisch sensor-  
gestuurde spoelkraan  
met stagnatiespoeling

Geïsoleerde  
buitenmuur



## MODULE 1

SOLID EDGE ACADEMIC COPY

Opdracht : bso-duaal	INSTALL SKILLS plumbing & heating Kortrijksestraat 389A 8500 Kortrijk <a href="http://www.installskills.be">www.installskills.be</a>	  	 <b>INSTALL SKILLS</b> plumbing & heating <small>www.installskills.be info@installskills.be 056 26 81 50</small>	Datum: 30/08/2023 A3
-------------------------	--	---	---	----------------------------

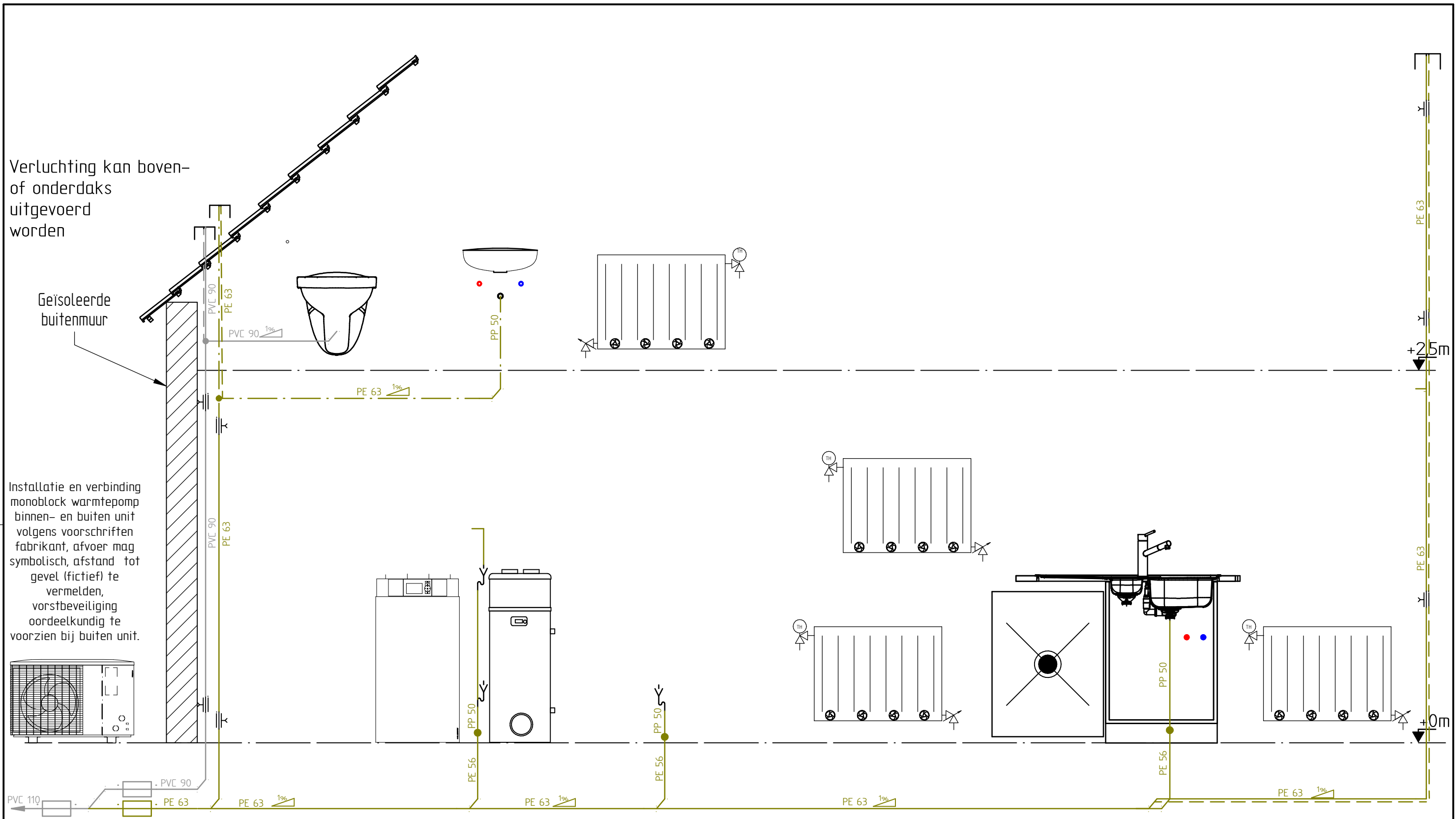

Verluchting kan boven- of onderdaks uitgevoerd worden

Geïsoleerde buitenmuur

Installatie en verbinding monoblock warmtepomp binnen- en buiten unit volgens voorschriften fabrikant, afvoer mag symbolisch, afstand tot gevel (fictief) te vermelden, vorstbeveiliging oordeelkundig te voorzien bij buiten unit.

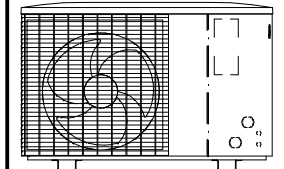

Tip: bocht 45° in chappe kan ook horizontaal (buizen voor elkaar i.p.v. boven elkaar)

# MODULE 1

SOLID EDGE ACADEMIC COPY

Opdracht : bso-duaal	INSTALL SKILLS plumbing & heating Kortrijksestraat 389A 8500 Kortrijk <a href="http://www.installskills.be">www.installskills.be</a>		 <b>INSTALL SKILLS</b> plumbing & heating <small>www.installskills.be info@installskills.be 056 26 81 50</small>	Datum: 30/08/2023 A3
-------------------------	--	--	---	----------------------------

Vulling van de CV installatie met behandeld water volgens richtlijnen ketel fabrikant.

4 radiatoren (totaal 5000 W op 45-35°C)

Ontluchters op alle hoogste punten CV installatie, aflaat op alle laagste punten monteren.

Hoekstopkranen te voorzien waar nodig.

Indicatief :  
voordruk en vuldruk van het expansievat met label markeren.

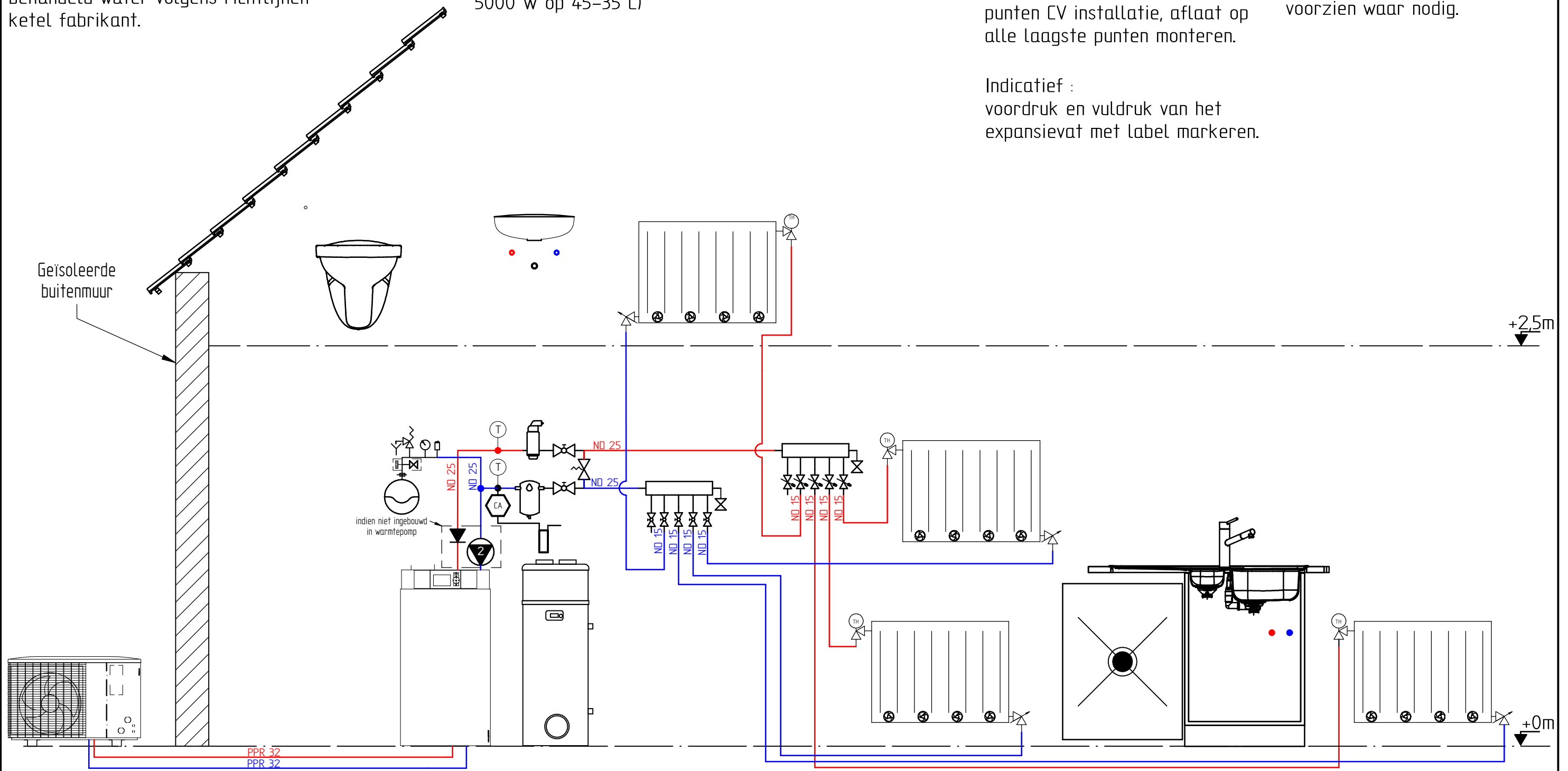

# MODULE 1



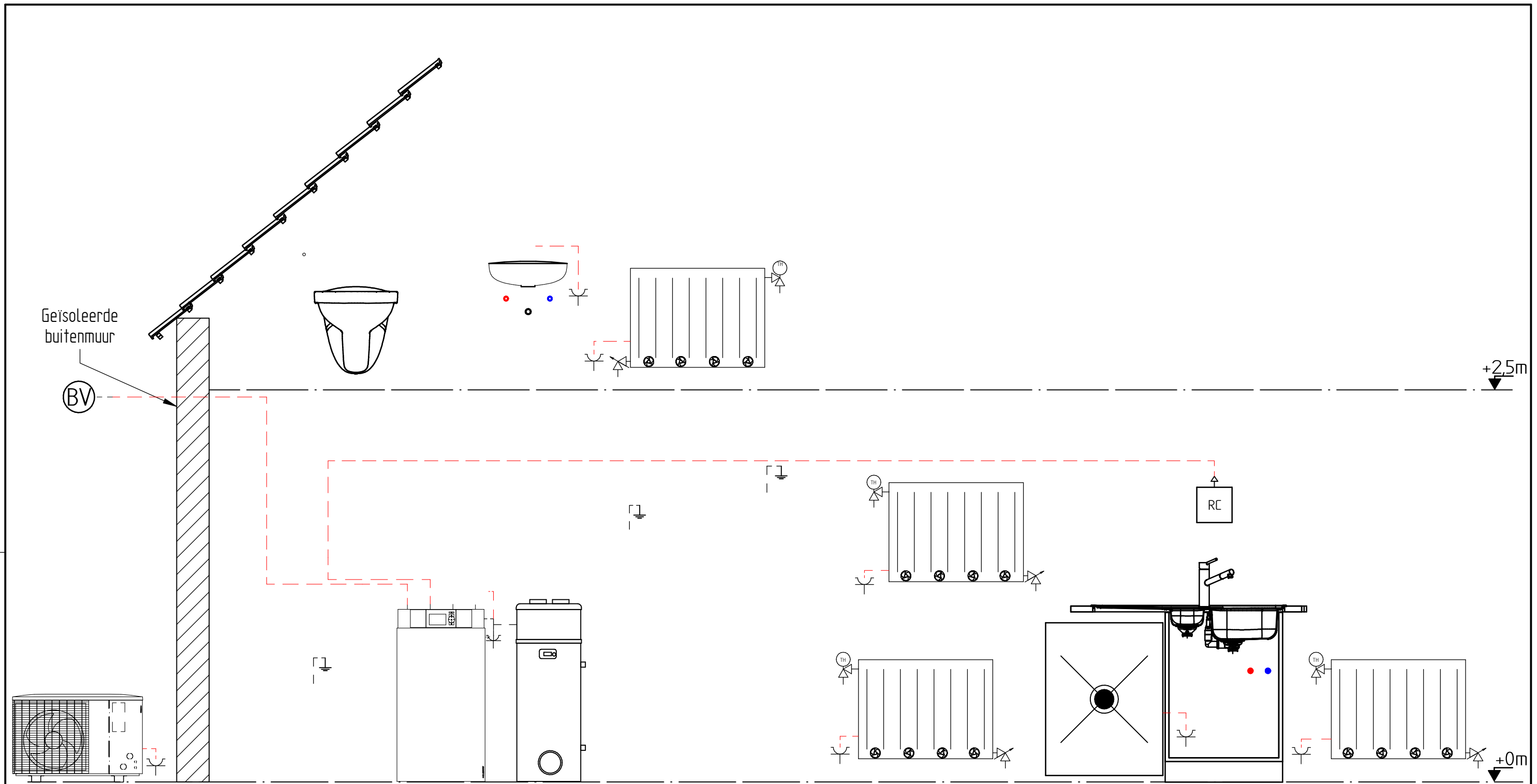

SOLID EDGE ACADEMIC COPY

Opdracht : bso-duaal	INSTALL SKILLS plumbing & heating Kortrijksestraat 389A 8500 Kortrijk <a href="http://www.installskills.be">www.installskills.be</a>		 <b>INSTALL SKILLS</b> plumbing & heating	Datum: 30/08/2023 A3
-------------------------	--	--	---	----------------------------



# MODULE 1

SOLID EDGE ACADEMIC COPY

Opdracht : bso-duaal	INSTALL SKILLS plumbing & heating Kortrijksestraat 389A 8500 Kortrijk <a href="http://www.installskills.be">www.installskills.be</a>	  	 <b>INSTALL SKILLS</b> plumbing & heating <small>www.installskills.be info@installskills.be 056 26 81 50</small>	Datum: 30/08/2023 A3
-------------------------	--	---	---	----------------------------

LEGENDE Sanitair - CV

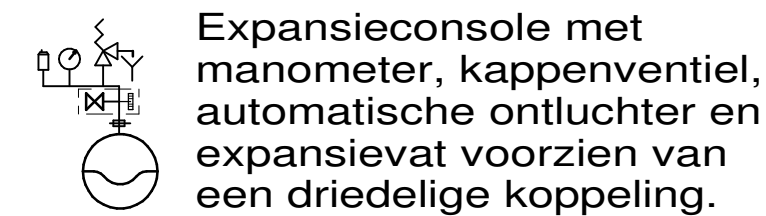
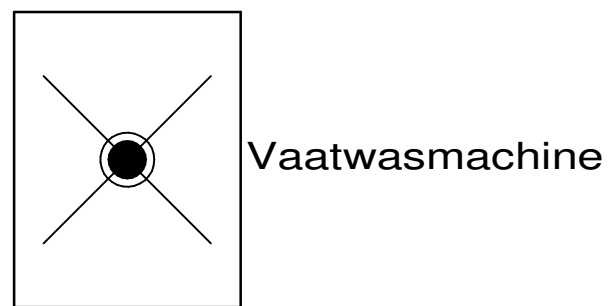
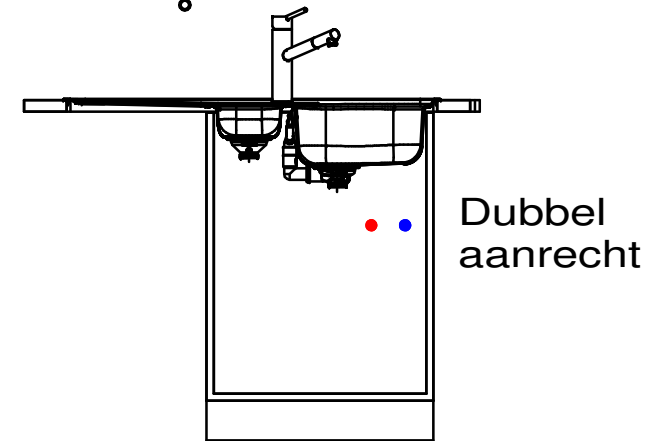
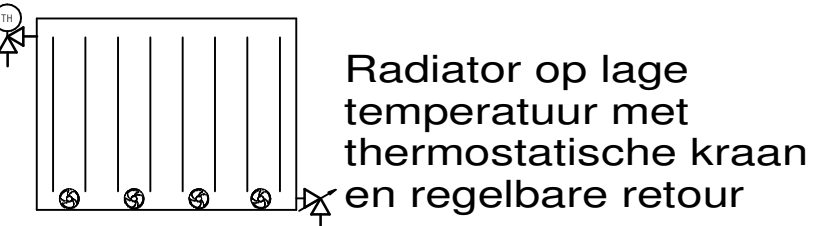
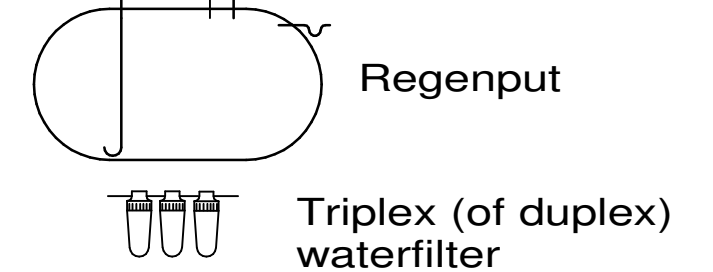
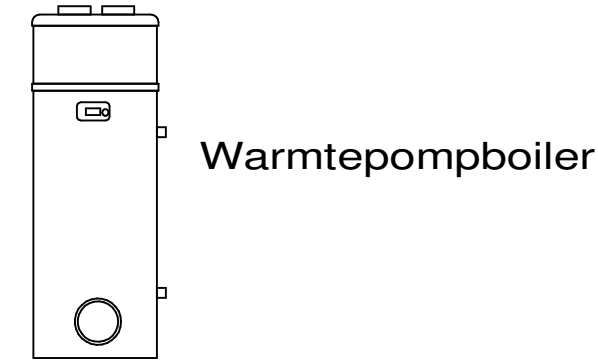
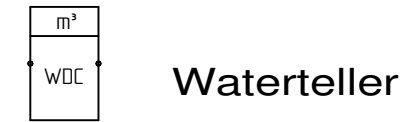
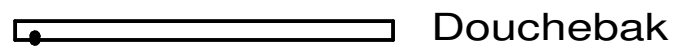
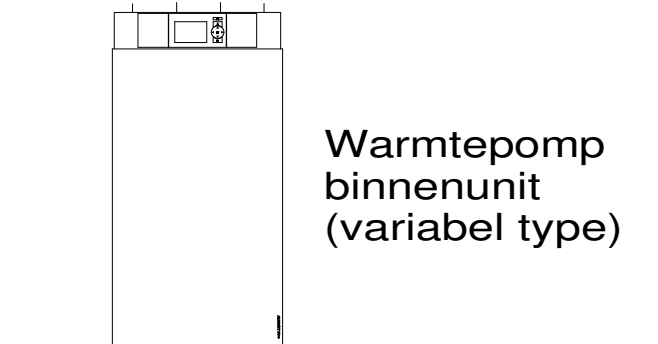
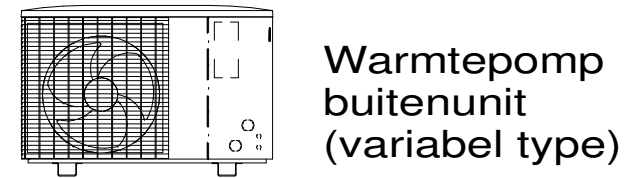
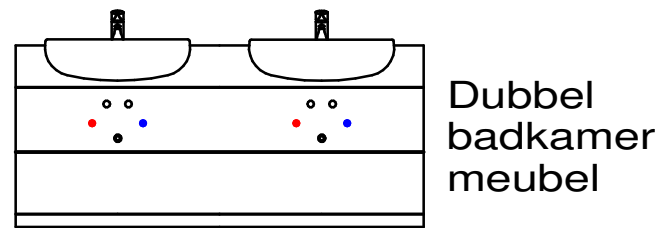
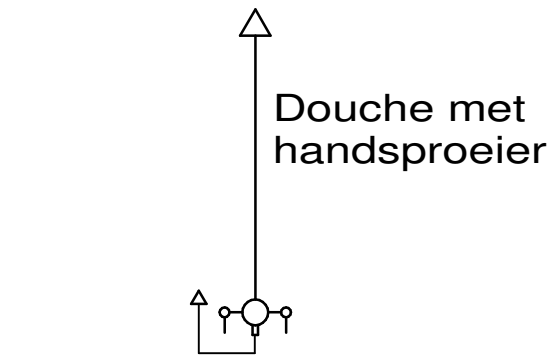

— PE — PPR

— PP — PVC

— PEX Meerlagenbuis

— Primaire verluchting



SOLID EDGE ACADEMIC COPY

Opdracht : bso-duaal  
Tekening nr. : 2/2

INSTALL SKILLS  
plumbing & heating  
Kortrijksestraat 389A  
8500 Kortrijk  
[www.installskills.be](http://www.installskills.be)



INSTALL SKILLS  
plumbing & heating  
[www.installskills.be](http://www.installskills.be) [info@installskills.be](mailto:info@installskills.be) 056 26 81 50

Datum: 30/08/2023  
A3