

Confederatie Bouw West Vlaanderen
 Kortrijksestraat 389 A - 8500 Kortrijk - T: 056/26 81 50
 Ten Briele 12 bus 1 - 8200 Brugge - T: 050/47 13 50
 mail: westvlaanderen@confederatiebouw.be
 web: www.confederatiebouw.be/westvlaanderen



VERKLARING AFKORTINGEN

Project **Scholenwedstrijd 2015-2016**
Confederatie bouw
West-Vlaanderen

Project Nr.		
Opgemaakt	Datum	Naam
	13/10/15	SB
Laatst bewerkt	01/11/15	

Inhoud **LEGENDE**

Tekeningnr.	Schaal
1.1	

16/10/15

LEIDINGEN

	AFVOERLEIDING		REGENWATER
	WARM WATER		AANVOERLEIDING CV
	RETOURLEIDING WARM WATER		RETOURLEIDING CV
	KOUD STADSWATER		GASLEIDING

SYMBOLEN

	VASTE BEUGEL		EA BEVEILIGING		
	OF	OF	TERUGSLAGKLEP		MECHANISCH AANGEDREVEN VLOEISTOPPOMP
	OF	AFSLUITER OF KLEP		EXPANSIEVAT	
	REGELKRAAN		LUCHTAFSCHEIDER		
	DRIEWEGKRAAN MET ELEKTROMAGNETISCHE MOTOR		VUILAFSCHEIDER		
	VEILIGHEIDSKLEP		Toilet		
	AUTOMATISCHE ONTLUCHTER		DOUCHE MET HANDSPROEIER		
	FILTER		STOP		
	TAPKRAAN		SCHUIFKOPPELING		
	WATERTELLER		LAVABO		
	MANOMETER		UITGIETBAK		
	DIËLECTRISCHE KOPPELING				

Confederatie Bouw West Vlaanderen Kortrijksestraat 389 A - 8500 Kortrijk - T: 056/26 81 50 Ten Briele 12 bus 1 - 8200 Brugge - T: 050/47 13 50 mail: westvlaanderen@confederatiebouw.be web: www.confederatiebouw.be/westvlaanderen			
Project Scholenwedstrijd 2015-2016 Confederatie Bouw West-Vlaanderen	Project Nr.		
	Opgemaakt	Datum	Naam
	Laatst bewerkt	01/11/15	
Inhoud OPDRACHT SANITAIR OPLOSSING	Tekeningnr.	Schaal	
	1.1		

16/10/15

ALLES OP EEN NIVEAU

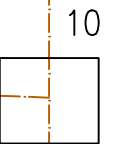
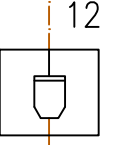
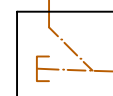
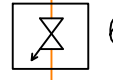
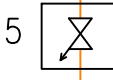
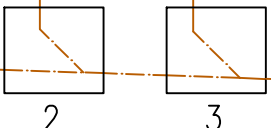
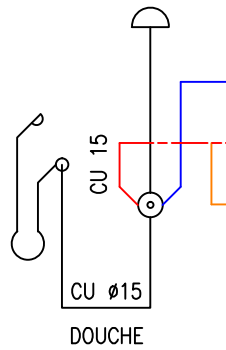
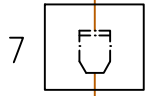
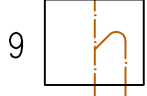
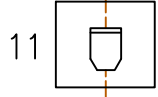
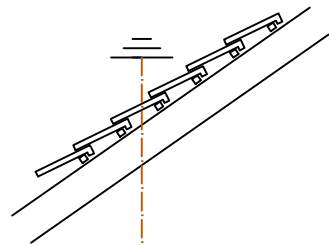

G 3/4

PPR 20

CU 18

CU 15

PE 50

PPR 20

PE 63

CU 15

PPR 25

G 3/4

PE 63

CU 15

PPR 25

G 3/4

PPR 20

PE 63

CU 15

PPR 20

PE 63

PE 50 AANSLUITING VOOR EIND-OF KOPVERLUCHTING VOOR 1 LAVABO OP HOGERE VERDIEPING

PE 63

CU 15

CU 18

G 3/4

PPR 20

PVC ø110

PVC 90 of 110

PPR 20

PVC ø110

PPR 25

CU 18

CU 15

PPR 20

PE 56

PE 53

PE 63

PE 63

PE 63

PE 63

PE 63

PE 63

PE 63

PE 63

PE 63

PE 63

PE 63

PE 63

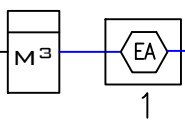

PPR 20

LEIDINGEN IN STAAL
(vrije keuze van verbinding:
schroef, persen of plooiën)

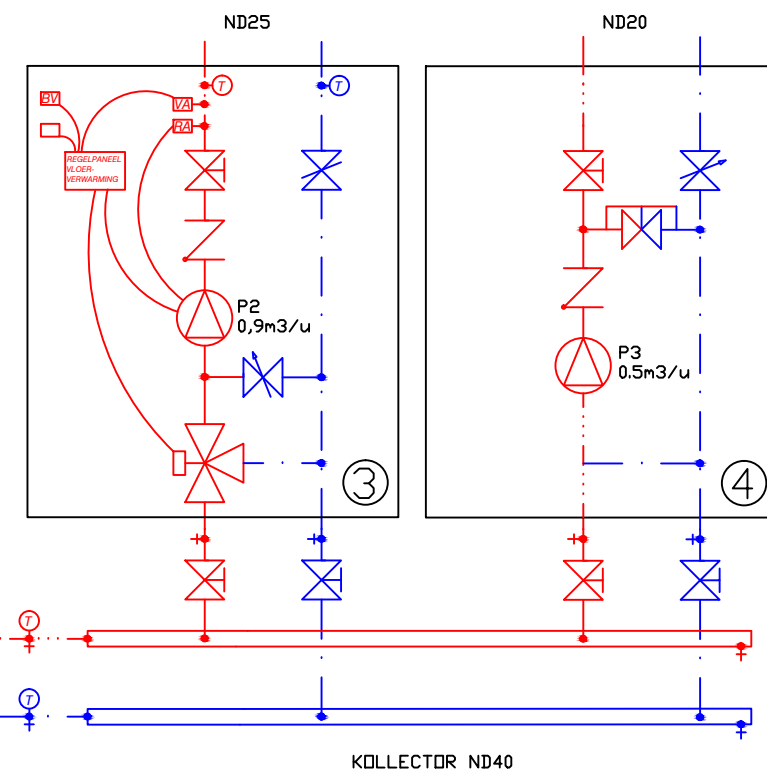
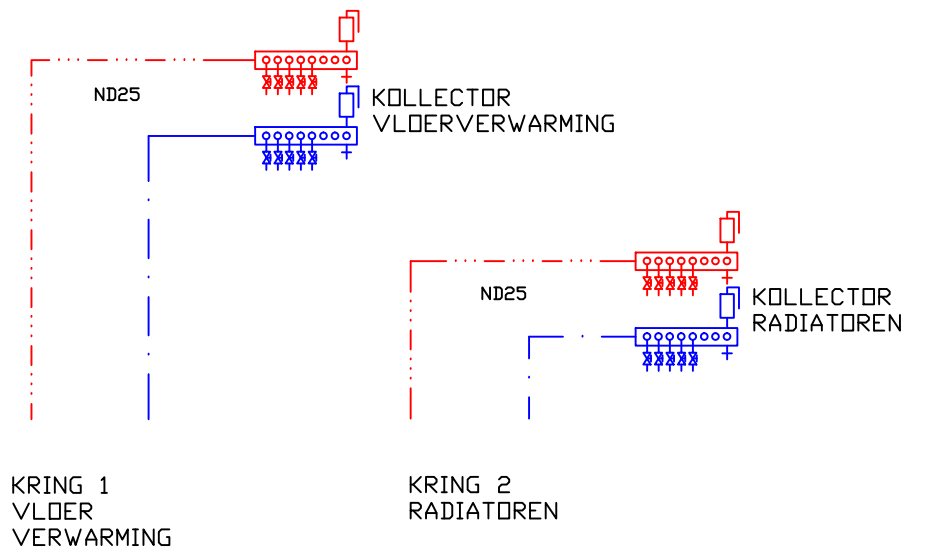
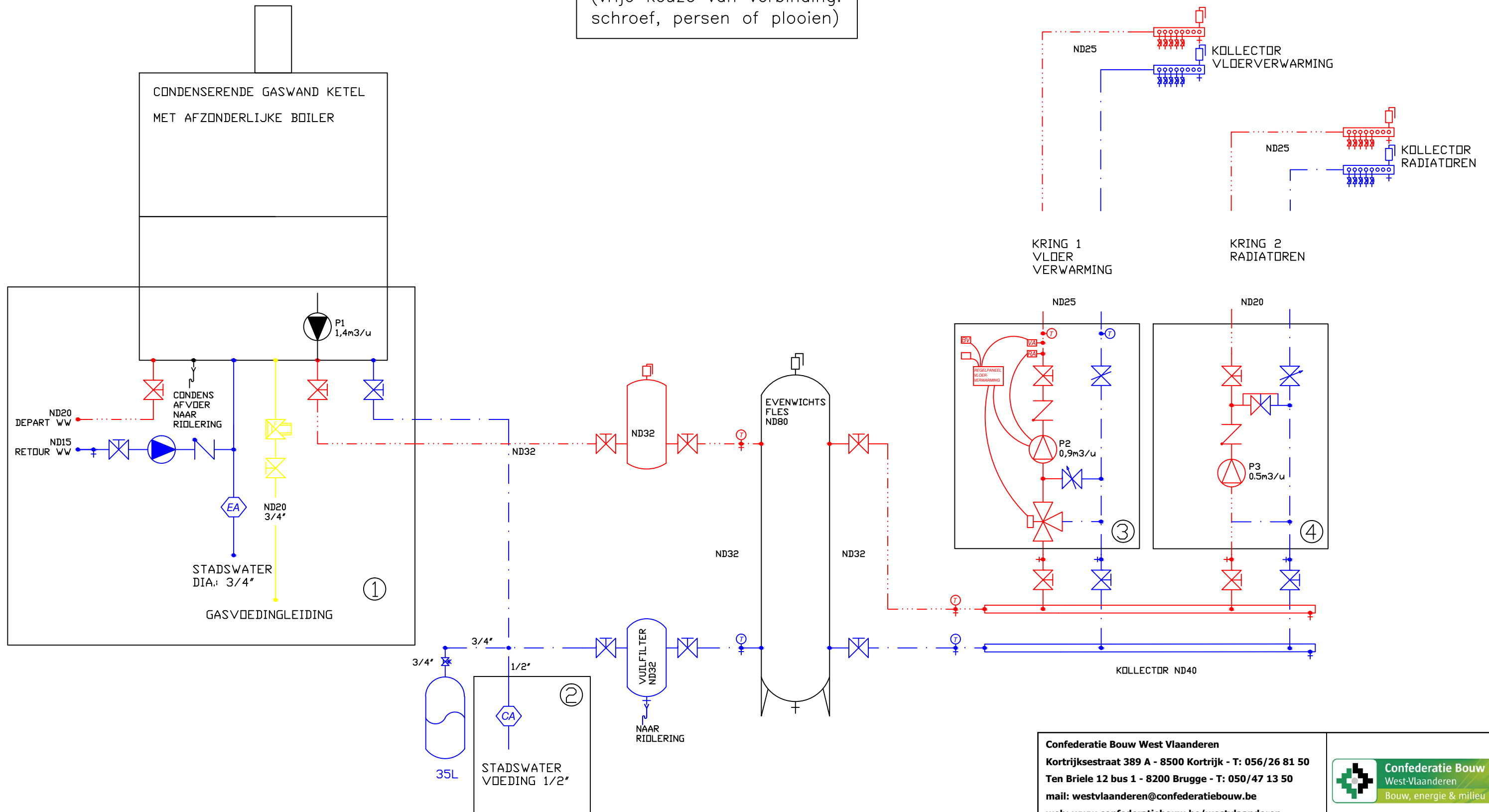

Confederatie Bouw West Vlaanderen
 Kortrijksestraat 389 A - 8500 Kortrijk - T: 056/26 81 50
 Ten Briele 12 bus 1 - 8200 Brugge - T: 050/47 13 50
 mail: westvlaanderen@confederatiebouw.be
 web: www.confederatiebouw.be/westvlaanderen



Project	Scholenwedstrijd 2015–2016 Confederatie bouw West–Vlaanderen	
Inhoud	OPDRACHT VERWARMING OPLOSSING	

Project Nr.		
Opgemaakt	Datum	Naam
Laatst bewerkt	13/10/15	SB
Tekeningnr.	Schaal	
1.1		